

INSTALLATION MANUAL

RIVAL

4x4 ACCESSORIES

PRODUCT: FRONT ALUMINUM BUMPER

APPLICATION: TOYOTA LAND CRUISER 250 (2024 - PRESENT)

PART NO: 2D.5726.1-NL



CAUTION!

To reduce the risk of serious injury or damage to property: Before you start installing and using this product, read the full instructions, pay special attention to the conditions of safe use and recommendations for installation! When installing or maintaining this product, it is necessary to use protective goggles. Check the integrity of the structure and the moment the fastening is tightened every 250 miles (400 kms) of mileage. Do not use this product if there is damage to the structure or fasteners!

NOTICE

Skid plate is an additional protection, but it can not guarantee to protect against all possible damage in collisions. When driving, be careful of objects and terrain that may damage sensitive parts of the vehicle.

FRONT BUMPER



Part number: 2D.5726.1-NL
Suited to vehicle: Toyota Land Cruiser 250
(2024 - Present)
Material: Aluminum / steel



SAFETY NOTICE

- * The RIVAL Bumper is designed to compliment the use and design of the specified vehicle under conditions specified by the vehicle manufacturer.
- * While driving the vehicle at any speed, collision with any other vehicle, animal or object must always be avoided.
- * Following any collision with any other vehicle, animal or object, the RIVAL Bumper and the vehicle must be inspected by a specialized or suitably qualified vehicle repairer for possible damage to the components and assemblies in order to confirm suitability for further use of the vehicle.
- * It is strongly recommended that you do not operate a vehicle with a damaged bumper or its components. In the case of damage, please contact the nearest RIVAL dealer. Vehicle, or where the bumper has been damaged, is extremely dangerous and must be avoided at all cost.
- * The operation of a vehicle where the bumper is not properly attached and fastened to the vehicle, or where the bumper has been damaged, is extremely dangerous and must be avoided at all cost.
- * It is recommended that you carry out regular inspections of all the bumper elements such as all bolts, wires, connectors.
- * A winch with a pull capacity of up to and including 12000 lb can be installed with the RIVAL Bumper. It is not advisable to exceed this pulling capacity since damage, injury or death may occur where the 12000lb recommended capacity is exceeded. The Rival bumper provides standard 4 1/2"x10" mounting holes.

INSTALLATION NOTICE

- * Personal safety during the installation process must be adhered to at all times.
- * Estimated time for installation: 4 hours.
- * The RIVAL Bumper must be mounted and affixed to the vehicle according to this installation manual and the use of personal safety equipment is highly recommended.
- * Do not install this bumper on vehicle models other than those allowed in this manual.
- * Check state and local highway safety laws regarding permitted bumper types and heights.

NOTE: if the bumper is to be color coded it is advised to test fit before color coding. RIVAL is not liable for color coding cost, it is the installers' responsibility to check the fitment and alignment before color coding.

ADR69 AND AIR BAG SYSTEM

The Rival bumper has been tested and certified to be compatible with ADR69 and will not affect the operation of the Air bag System on this vehicle. This product or mounting brackets must not be modified in any way, and must be fitted in accordance with the installation instructions.

REQUIRED TOOLS

- * Basic tool kit
- * Torque wrench
- * Crosspoint and flat head screwdriver
- * Screwdriver Torx T6
- * Retaining ring forcep
- * Masking tape
- * Marker
- * Drill

TORQUE SETTING

- * M6 - 9 N·m
- * M8 - 24 N·m
- * M10 - 44 N·m
- * M12 - 77 N·m

WINCH INSTALLATION

A winch with a pull capacity of up to 12000 lbs can be installed with the RIVAL Bumper. It is not advisable to exceed this pulling capacity since damage, injury or death may occur where the 12000 lbs recommended capacity is exceeded.

Winch measurements:

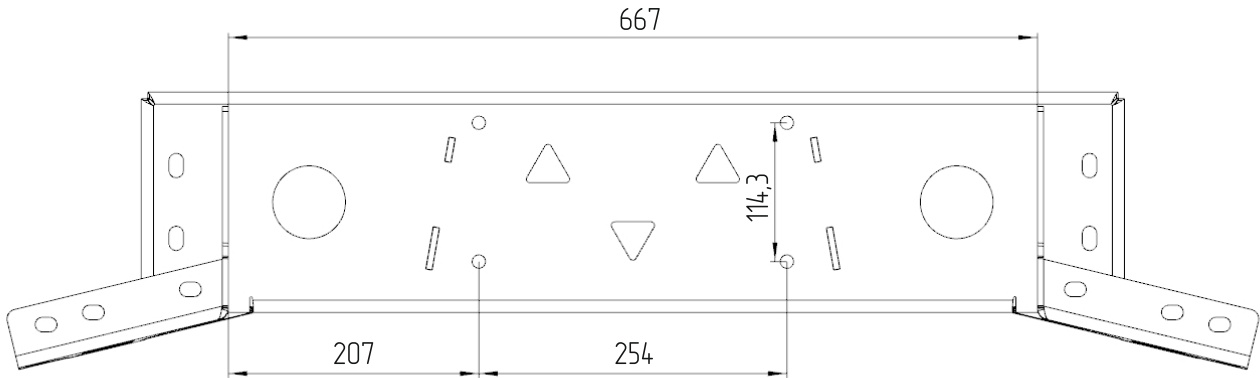

Winch size limits:

L 667 x W 230 mm x H 240 mm

LIGHTBAR

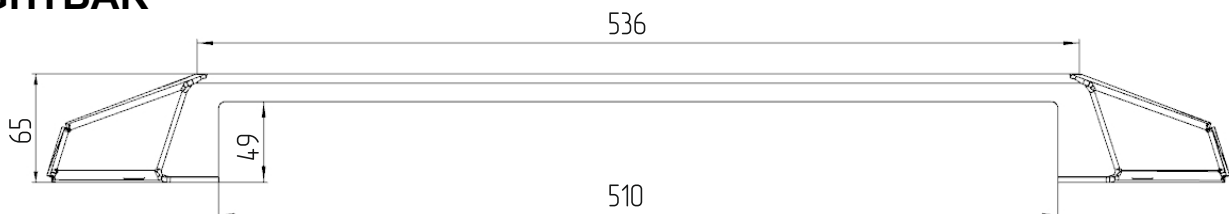

Lightbar size limits:

L 536 x W 69 mm x H 62 mm

LIGHTS

The bumper provides for the light mounting points.

Overall dimensions of the lights under installation:

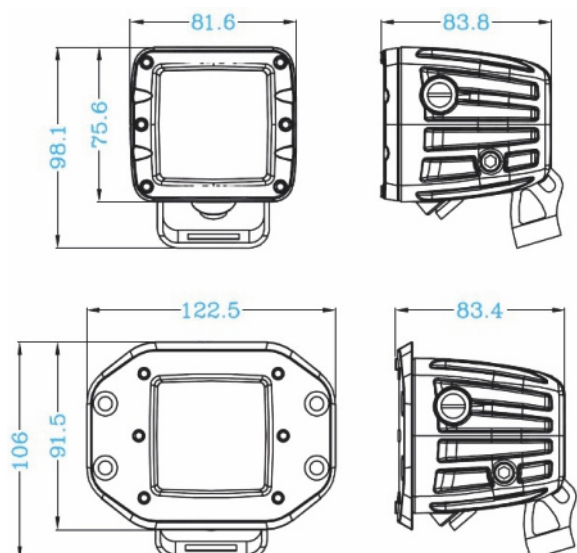

RECOVERY POINTS



WARNING!

Do not exceed the 5000 KGS Working Load Limit of these recovery points or shackle.

INSPECTION AND SAFETY

Recovery of stuck vehicles can be dangerous. Always inspect the shackle and recovery points before each use. Do not use if there are visible signs of damage or wear including cracking (or elongation). Always stay a safe distance away from the recovery area - at least 1.5 times the length of the recovery strap. Incorrect use of receivers equipment can result in serious injury or death.

Always use recovery points as a matched pair teamed with an equalising bridle during any recovery situation.

Please attach this "Warning" label to the door aperture.

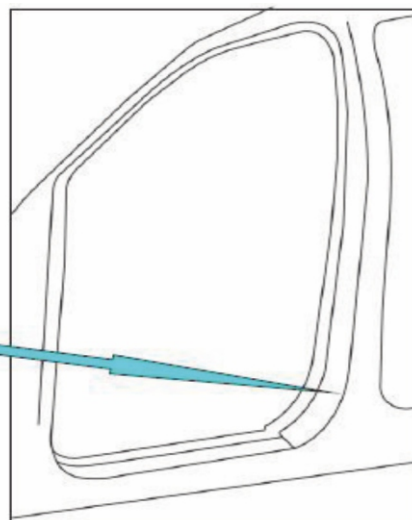

PARTS LISTING



4x4 ACCESSORIES

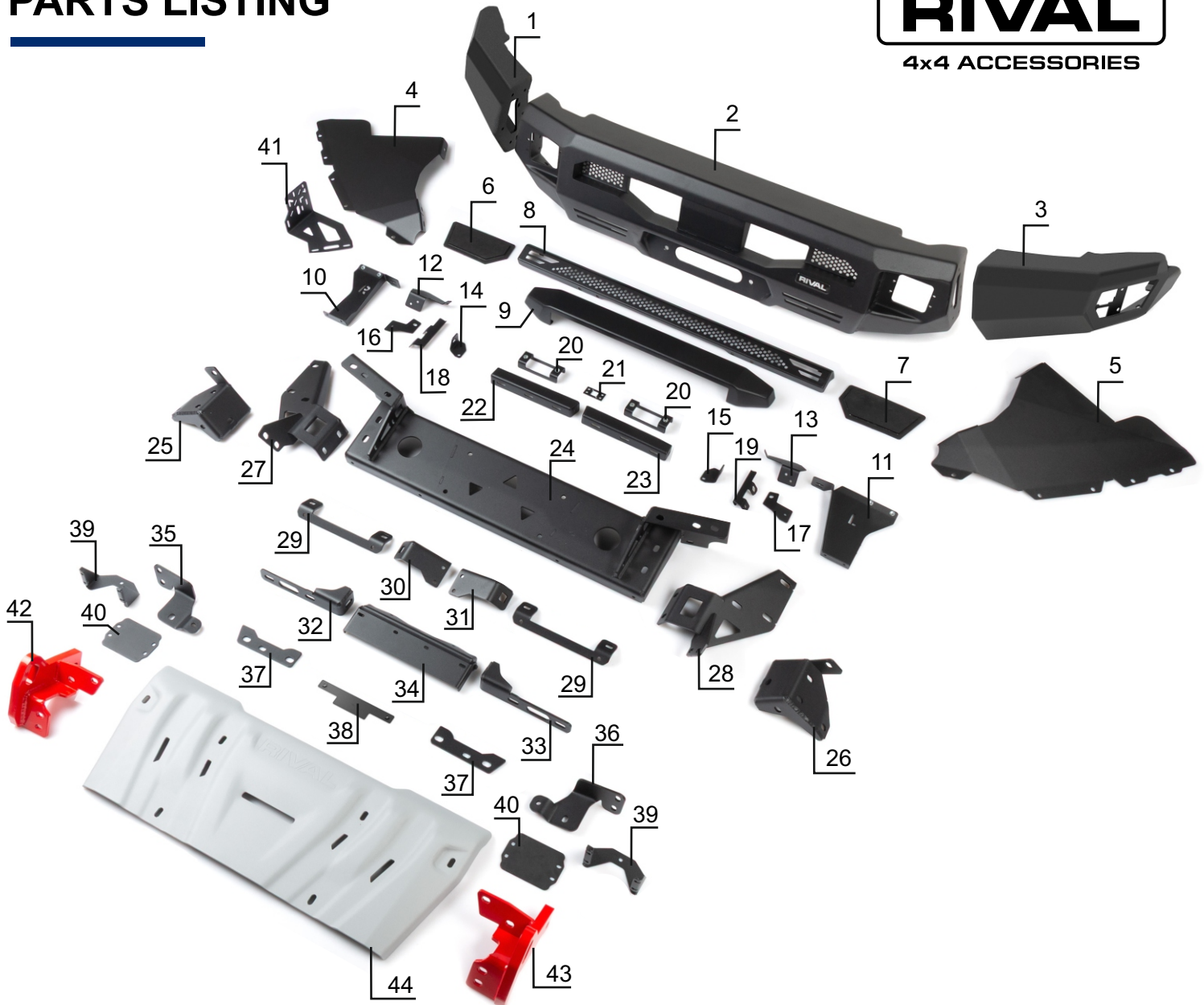

1. Right end cap.....	Qty 1	23. Right central bracket.....	Qty 1
2. Bumper body.....	Qty 1	24. Winch bracket.....	Qty 1
3. Left end cap.....	Qty 1	25. Right reinforcing bracket.....	Qty 1
4. Right flap.....	Qty 1	26. Left reinforcing bracket.....	Qty 1
5. Left flap.....	Qty 1	27. Right frame bracket.....	Qty 1
6. Right plastic plug.....	Qty 1	28. Left frame bracket.....	Qty 1
7. Left plastic plug.....	Qty 1	29. Front bash plate bracket.....	Qty 2
8. Grille.....	Qty 1	30. Right rear bash plate bracket.....	Qty 1
9. Lightbar cap.....	Qty 1	31. Left rear bash plate bracket.....	Qty 1
10. Right grille bracket.....	Qty 1	32. Right fairlead bracket.....	Qty 1
11. Left grille bracket.....	Qty 1	33. Left fairlead bracket.....	Qty 1
12. Right fender bracket.....	Qty 1	34. License plate bracket.....	Qty 1
13. Left fender bracket.....	Qty 1	35. Right bracket.....	Qty 1
14. Right lightbar bracket.....	Qty 1	36. Left bracket.....	Qty 1
15. Left lightbar bracket.....	Qty 1	37. Frame bracket.....	Qty 2
16. Right lower bracket.....	Qty 1	38. License plate insert nut.....	Qty 1
17. Left lower bracket.....	Qty 1	39. LED bracket.....	Qty 2
18. Right upper bracket.....	Qty 1	40. LED light cap.....	Qty 2
19. Left upper bracket.....	Qty 1	41. Winch control box bracket.....	Qty 1
20. Radar bracket.....	Qty 2	42. Right recovery point.....	Qty 1
21. Camera bracket.....	Qty 1	43. Left recovery point.....	Qty 1
22. Left central bracket.....	Qty 1	44. Bash plate.....	Qty 1

PARTS LISTING

RIVAL

4x4 ACCESSORIES

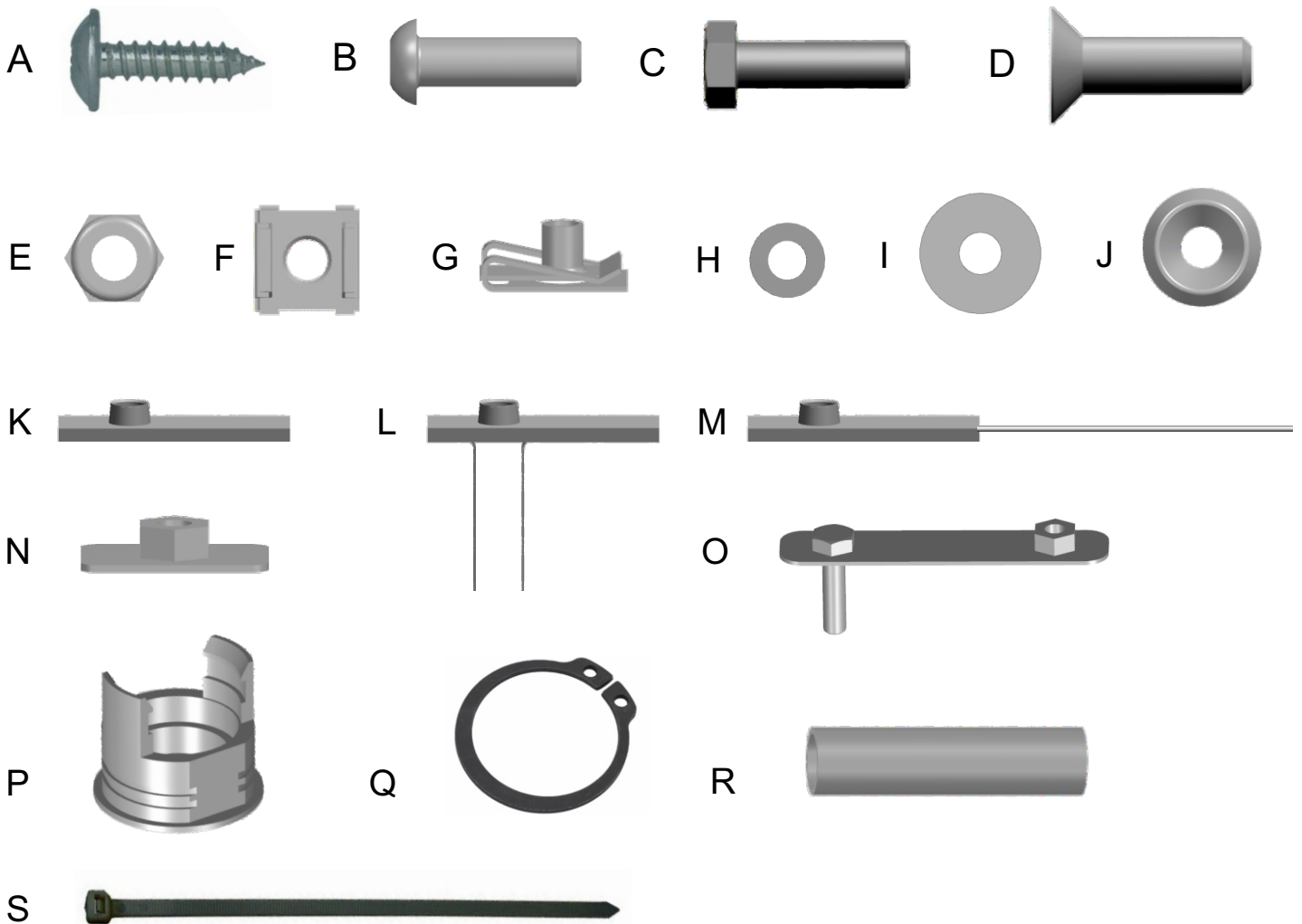

A. Self-tapping screw M4.8x1.6x22.....	Qty 2	H1. Washer M6.....	Qty 22
B. Screw M6x1x20.....	Qty 32	H2. Washer M12.....	Qty 4
C1. Bolt M6x1x20.....	Qty 26	I1. Penny washer M6.....	Qty 42
C2. Bolt M6x1x35.....	Qty 8	I2. Penny washer M8.....	Qty 52
C3. Bolt M8x1.25x30.....	Qty 28	I3. Penny washer M10.....	Qty 58
C4. Bolt M10x1.5x30.....	Qty 26	J. Countersunk washer M10.....	Qty 8
C5. Bolt M10x1.5x40.....	Qty 4	K. Insert nut M10x1.5x65.....	Qty 2
C6. Bolt M12x1.75x120.....	Qty 2	L. Insert nut with wires M10x1.5x65.....	Qty 6
D. Screw M10x1.5x30.....	Qty 8	M. Insert nut with wire M10x1.5x65.....	Qty 2
E1. Nut M6x1.....	Qty 14	N. Insert nut M10x1.5x43x30.....	Qty 2
E2. Nut M8x1.25.....	Qty 24	O. Insert nut M10x1.5.....	Qty 2
E3. Nut M10x1.5.....	Qty 28	P. Parking sensor holder.....	Qty 6
E4. Nut M12x1.75.....	Qty 2	Q. Retaining ring.....	Qty 4
F. Cage nut M8x1.25.....	Qty 4	R. Spacer.....	Qty 2
G. Cage nut M6x1.....	Qty 26	S. Cable tie.....	Qty 16

Preparation for installation

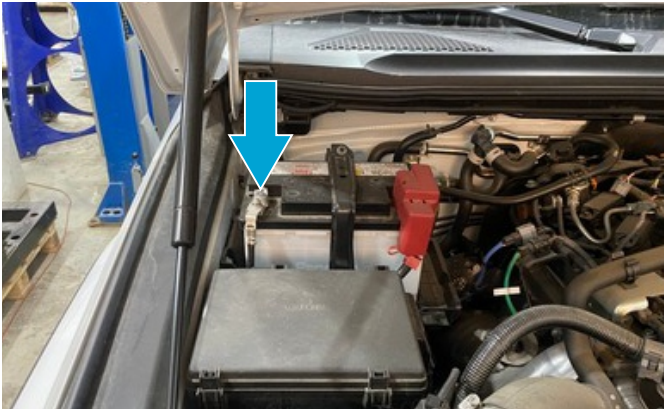

Fig.1

1. Open the hood. Disconnect terminal “-” from the vehicle battery (fig.1).

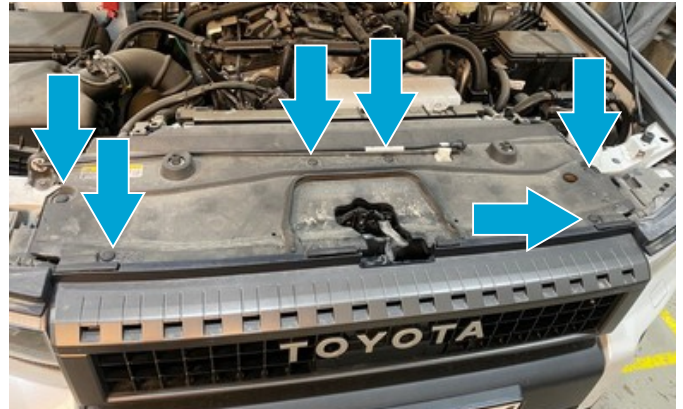

Fig.2

2. Release the phillips head clips to remove the top cover (fig. 2).

***Set aside for re-use later on.**

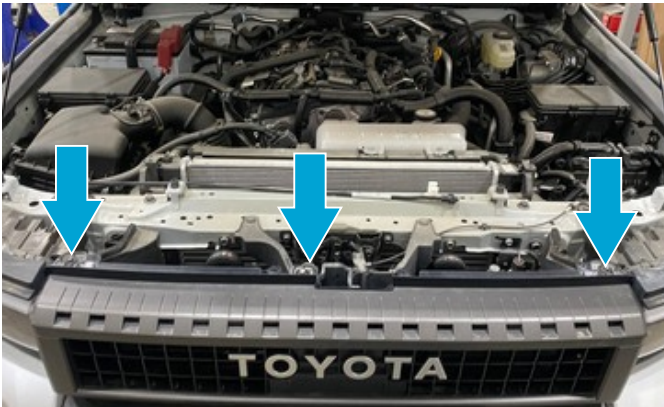

Fig.3

3. Unscrew factory bolts (fig.3).

***Set aside for re-use later on.**



Fig.4

4. Mark a cutting line as shown in fig 4.



Fig.5

5. Remove plastic clips and factory bolts to take off factory mud flaps.

***Set aside for re-use later on.**



Fig.6

6. Remove plastic clips and factory bolts to take off factory fenders.

***Set aside for re-use later on.**

INSTALLATION PROCEDURE

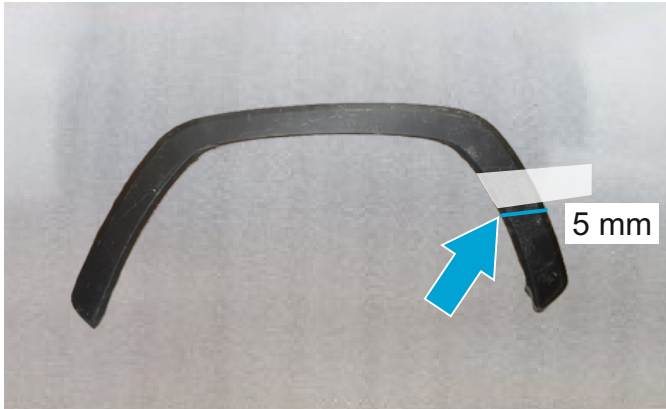

Fig.7

7. Step back 5mm from the marked line and cut the fender.

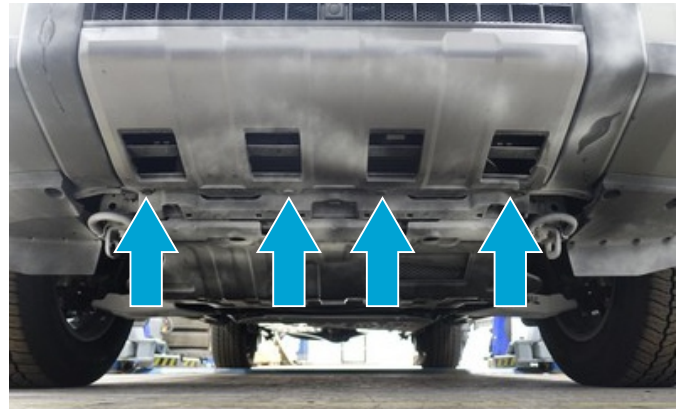

Fig.8

8. Remove the bolts and clips from the bottom of the bumper.



Fig.9

9. Remove the bolts and clips from the right and left sides of the bumper.



Fig.10

10. Disconnect the factory wiring from the right side of the bumper (fig.10).



Fig.11

11. Disconnect the factory wiring from the right side of the bumper (fig.11).



Fig.12

12. Make sure the washer reservoir is empty. If necessary, prepare a container, disconnect the hose, and drain it.

INSTALLATION PROCEDURE

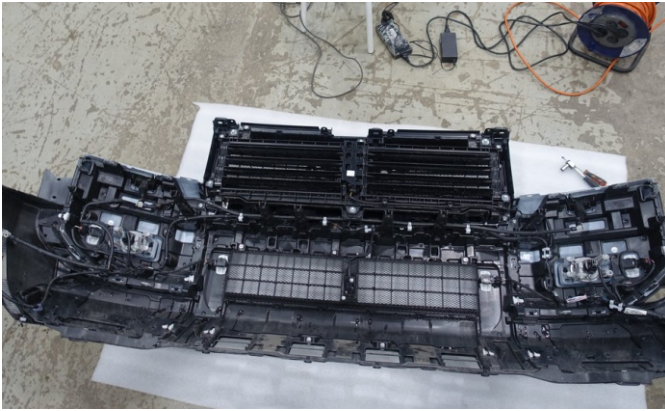

Fig.13

13. Remove the bumper with the radiator grille.
***Set aside for re-use later on.**

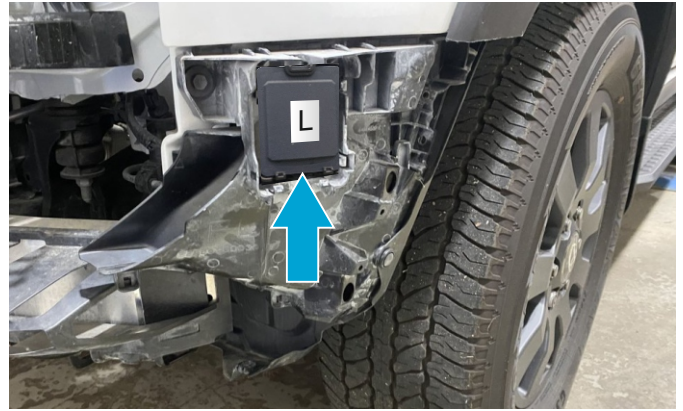

Fig.14

14. If there are front side radars, mark them (right, left), then remove them.



Fig.15

15. Unscrew and remove the plastic bracket of the side radar.

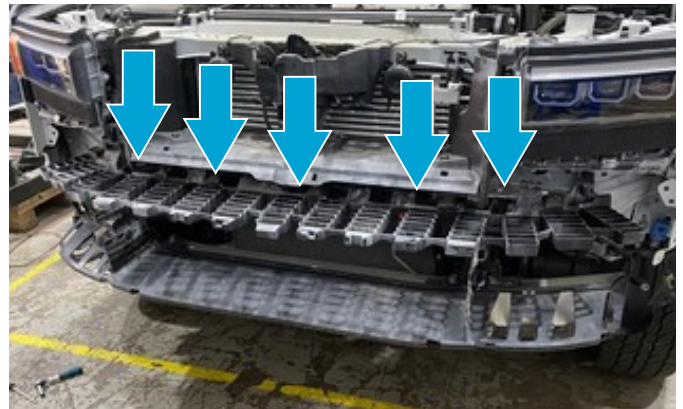

Fig.16

16. Unscrew and remove the front plastic cover.

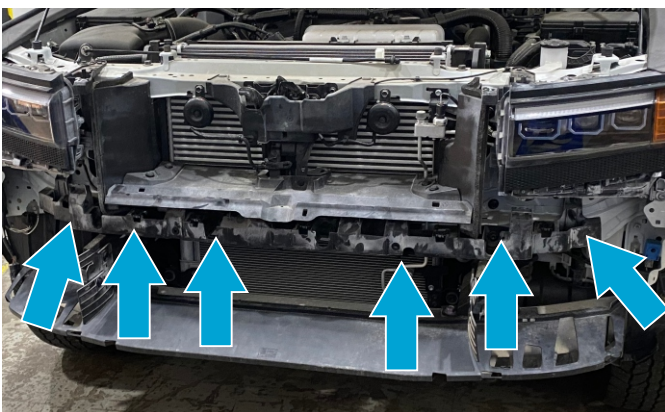

Fig.17

17. Unscrew and remove the front plastic overlay .

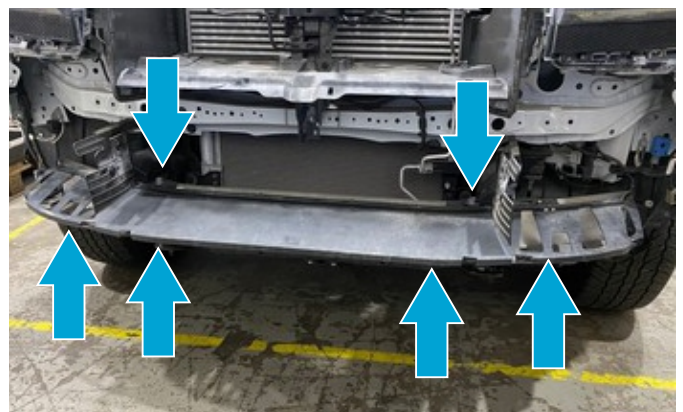

Fig.18

18. Unscrew and remove the front plastic cover.

INSTALLATION PROCEDURE

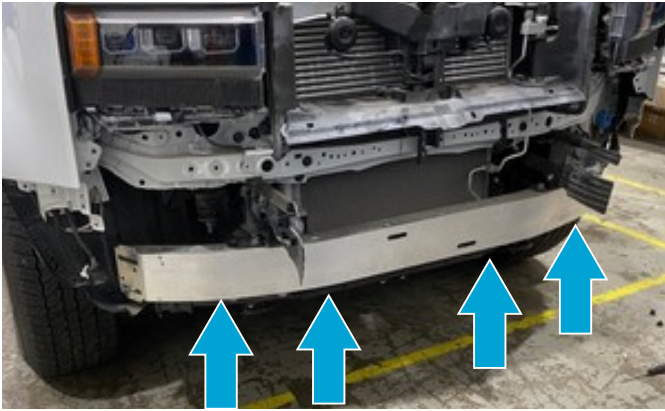

Fig.19

19. Unscrew bolts and remove factory crossmember (fig. 19).

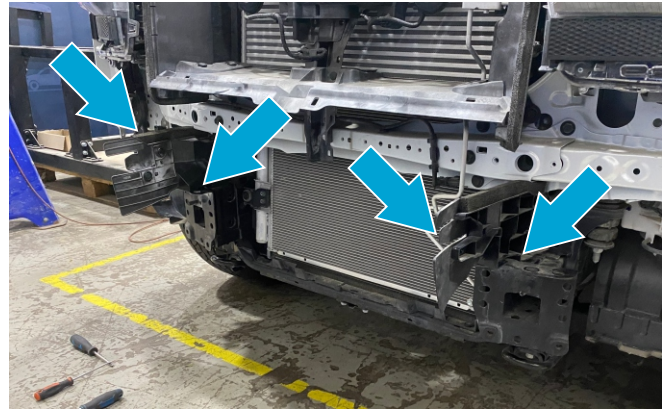

Fig.20

20. Unscrew the bolts and remove the side plastic trims.

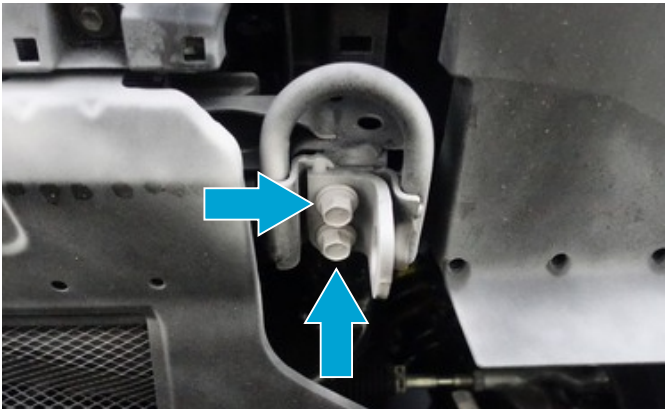

Fig.21

21. Unscrew bolts and remove factory recovery points.

***Set aside for re-use later on.**

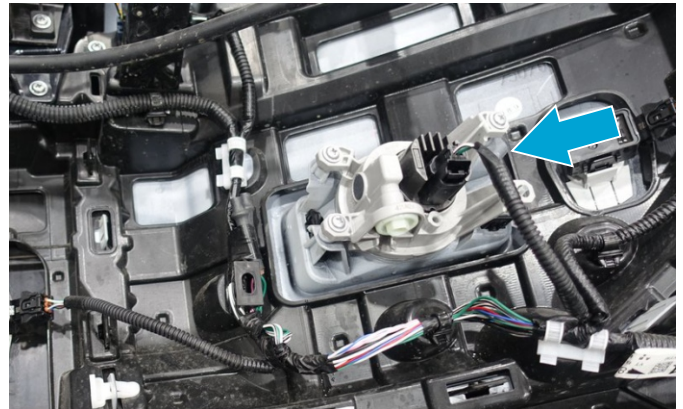

Fig.22

22. Disconnect the wiring from the fog lights.

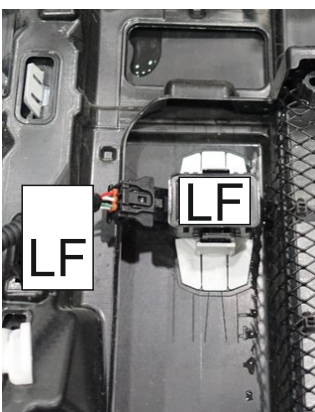

Fig.23

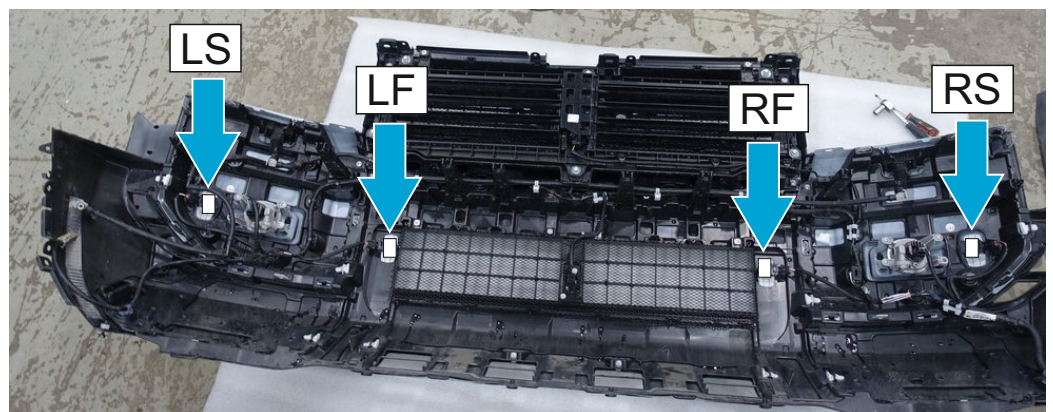

Fig.24

23. Mark the parking sensors and wires as shown (Fig. 24). Then disconnect it from the wires and remove from the bumper.

INSTALLATION PROCEDURE

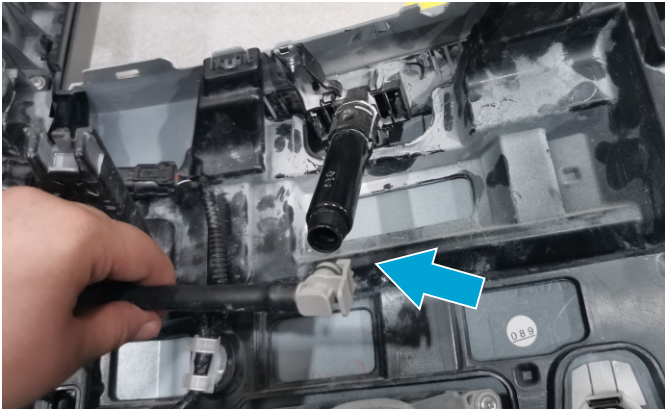

Fig.25

24. Disconnect the hose from the headlight washer on both sides.



Fig.26

25. Mark the top side of the camera and the plug.



Fig.27

26. Disconnect the wire from the camera. Unscrew the bolts and remove the camera with the bracket.



Fig.28

27. Unscrew the bolts using a Torx T6 screwdriver. Remove the camera from the bracket.
***Set aside hardware for re-use later on.**

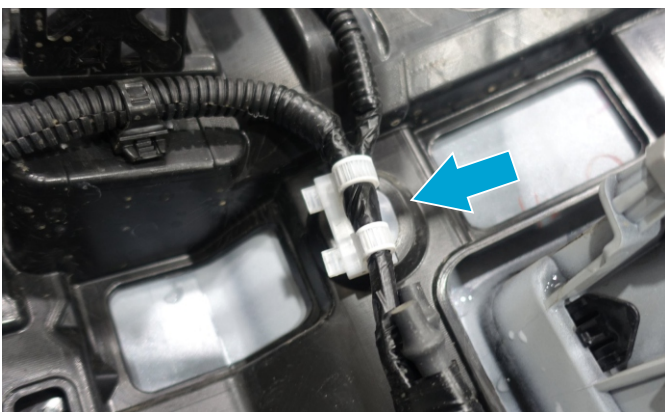

Fig.29

28. Unclip all wiring clips from the bumper.

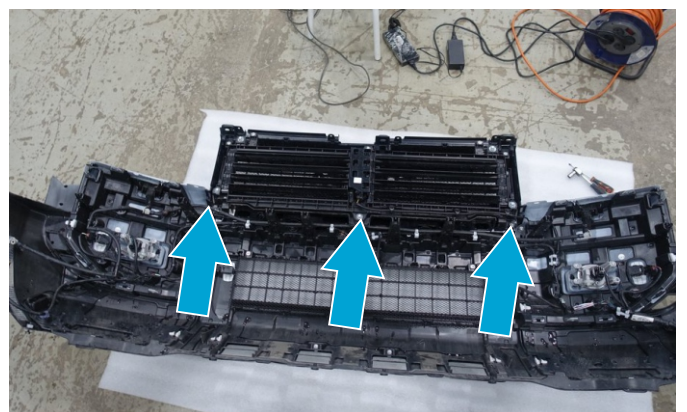

Fig.30

29. Unscrew the bolts and detach the grille from the bumper.

INSTALLATION PROCEDURE



Fig.31

30. Remove the headlight washer pads.

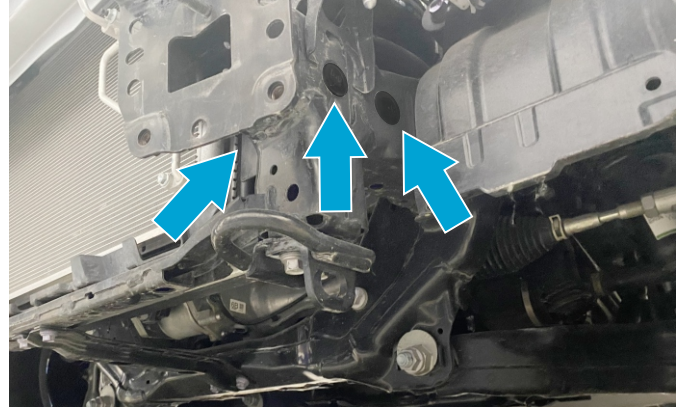

Fig.32

31. Remove the plugs from the inside and outside of the frame.

***On both sides.**

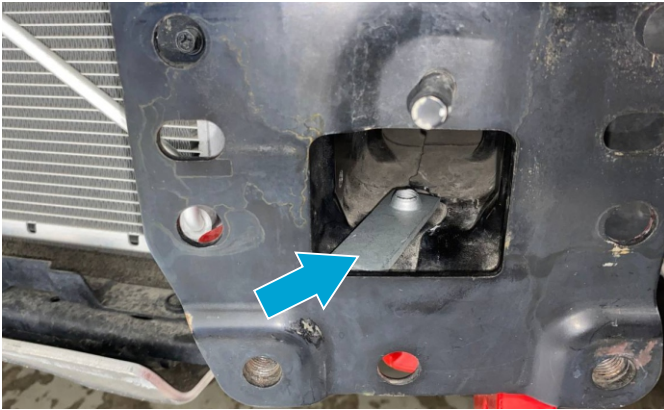

Fig.34

32. Install insert nut M10 (item K).

***On both sides.**

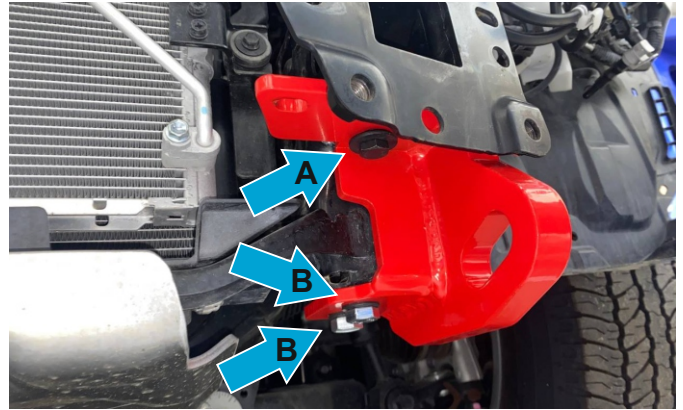

Fig.34

33. Install the recovery points (items 42, 43) on the frame using:

A - Bolts M10x30 and penny washers (items C4, I3);

B - OE bolts.

***Do not tighten yet.**

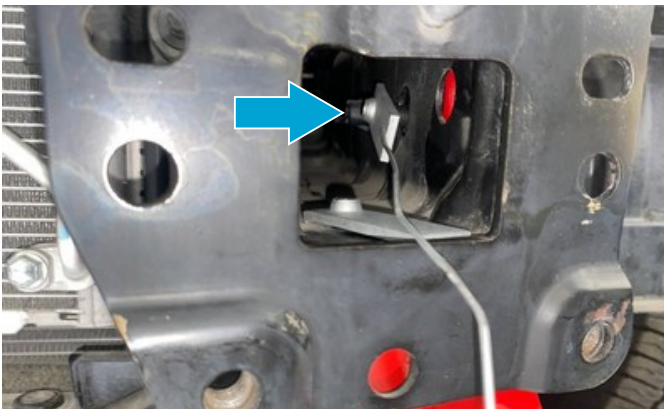

Fig.35

34. Install and secure the brackets (items 35, 36) using M10x30 bolts, M10 penny washers, socket nuts M10 with wire (item C4, I3, M) on both sides..

***Do not tighten yet.**

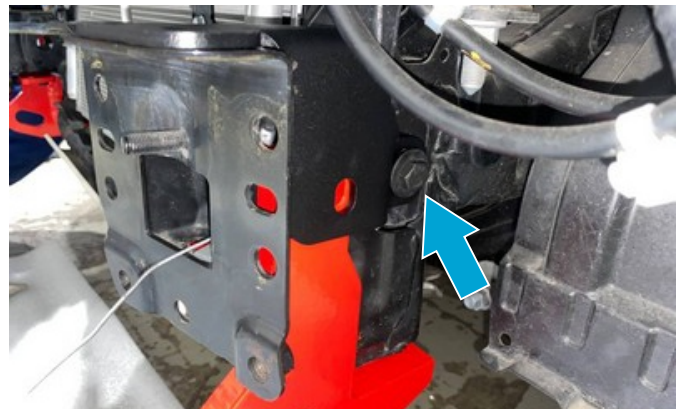

Fig.36

INSTALLATION PROCEDURE

RIVAL

4x4 ACCESSORIES



Fig.37

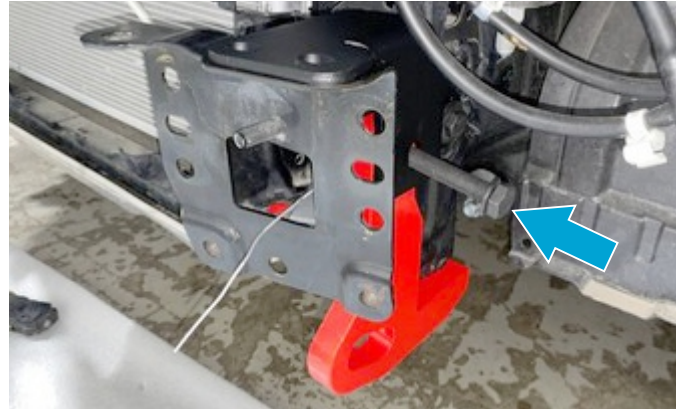

Fig.38

35. Install and secure the brackets (items 25, 26) on frame using M12x120 bolts, M12 washers, spacer, nuts M12 wire (item C6, H2, R, E4) on both sides..

***Do not tighten yet.**

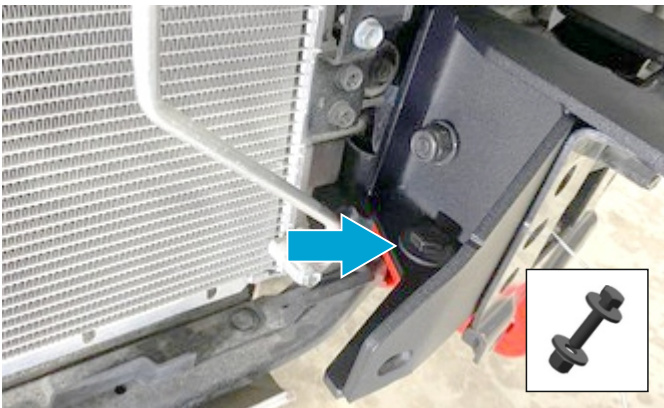

Fig.39

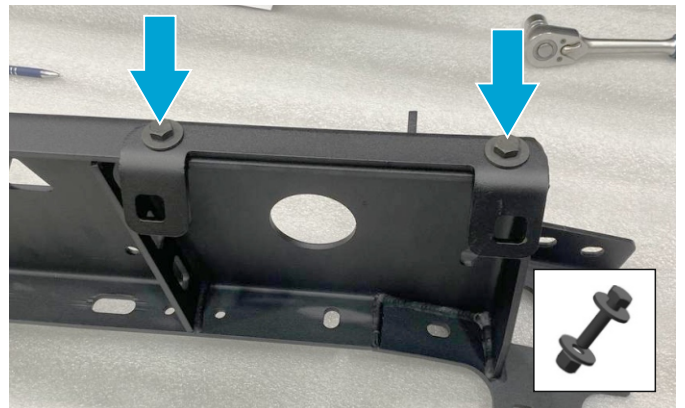

Fig.40

36. Attach the brackets with towing points using M10 bolts (items C4, E3, I3) on both sides.

***Do not tighten yet.**

37. Attach the front bashplate brackets (item 29) to the winch bracket (item 24) using M8x30 bolts, M8 penny washers and M8 nuts (items C3, E2, I2).

***Tighten the hardware.**



Fig.41

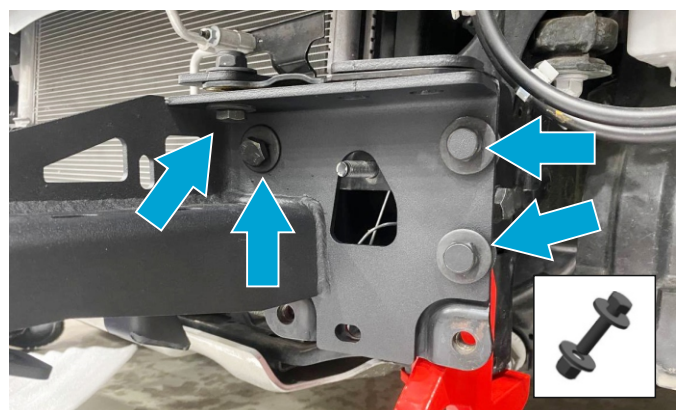

Fig.42

38. Attach the rear bashplate brackets (items 30, 31) to the winch bracket (item 24) using M8x30 bolts, M8 penny washers, M8 nuts (items C3, E2, I2).

***Tighten the hardware.**

39. Install the winch bracket (item 24) on the vehicle using M10x30 bolts, M10 penny washers (items C4, E3, I3).

***Do not tighten yet.**

INSTALLATION PROCEDURE

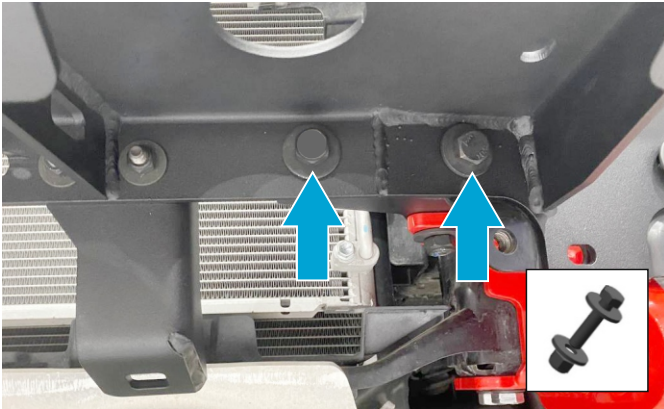

Fig.43

40. Fix the winch bracket (item 24) using M10x30 bolts, M10 penny washers and M10 nuts (items C4, E3, I3).
***Do not tighten yet.**

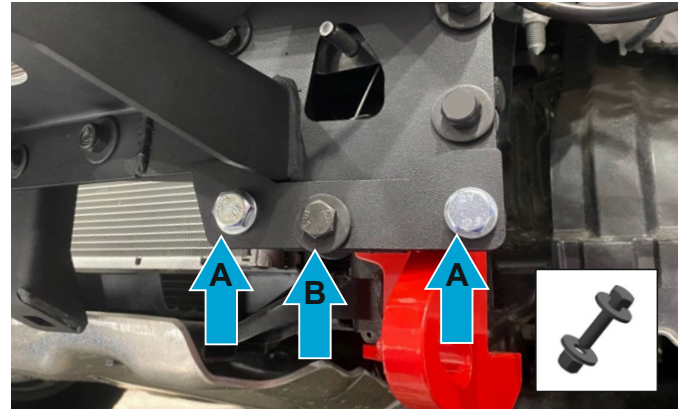

Fig.44

41. Install frame brackets (item 37) as shown in Fig. 44.
A - 4 OE bolts.
B - M10x30 bolts, M10 penny washers, M10 nuts (C4, E3, I3).
Do not tighten yet.

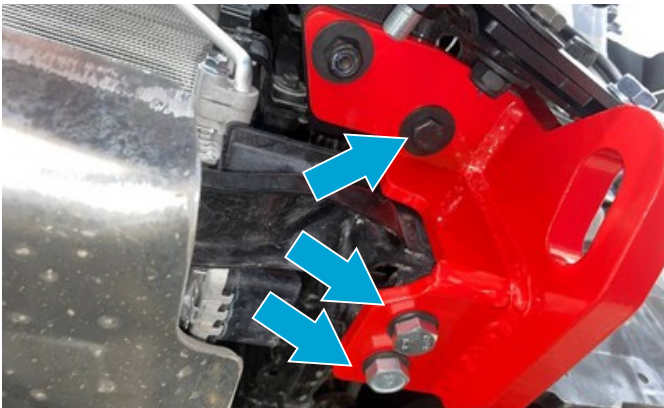

Fig.45

42. Tighten the hardware shown in Fig.45.
***On both sides.**

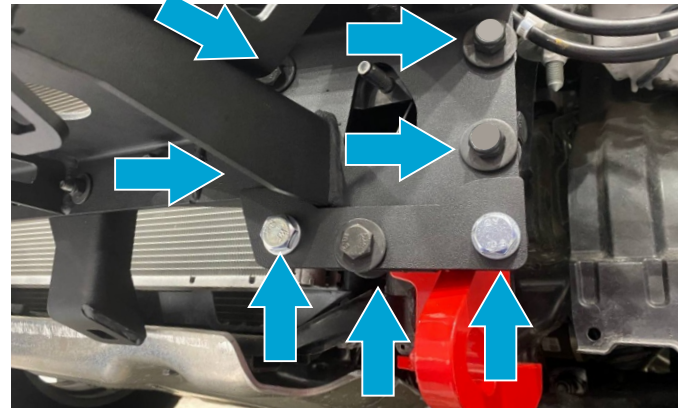

Fig.46

43. Tighten the hardware shown in Fig.46.
***On both sides.**

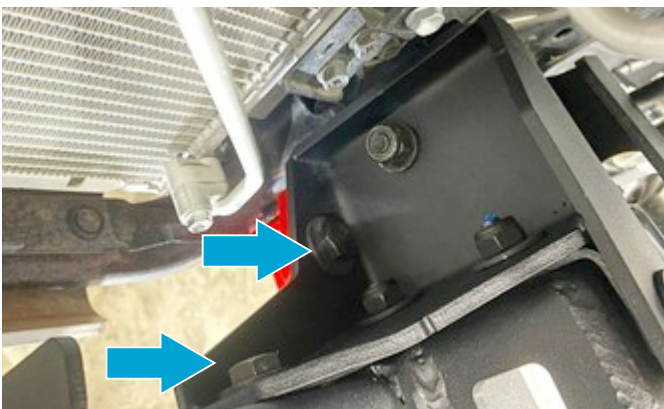

Fig.47

44. Tighten the hardware shown in Fig.47.
***On both sides.**



Fig.48

45. Tighten the hardware shown in Fig.48.
***On both sides.**

INSTALLATION PROCEDURE

RIVAL

4x4 ACCESSORIES

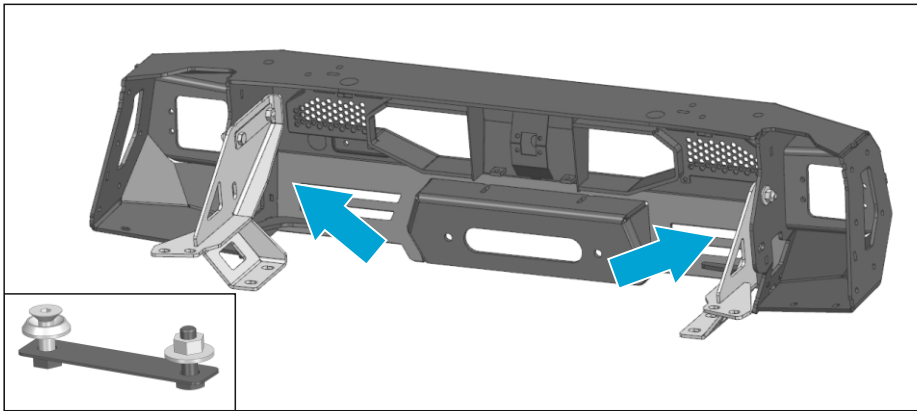

Fig.49

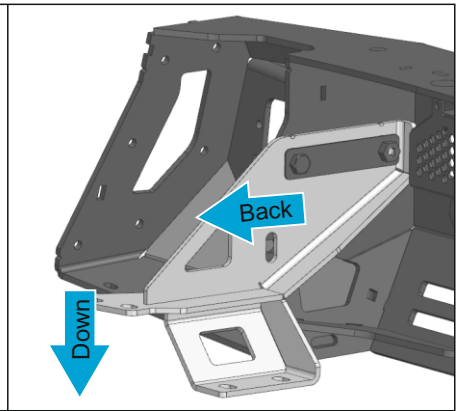

Fig.50

46. Install the frame bracket (item 27, 28) to the bumper body (item 2) using M10 insert nut, M10 screw, M10 countersunk washers, M10 penny washers, M10 nuts (items D, E3, I3, G, O) (Fig. 49). Slide the brackets back and down as shown in Fig. 50. ***Tighten the hardware.**



Fig.51

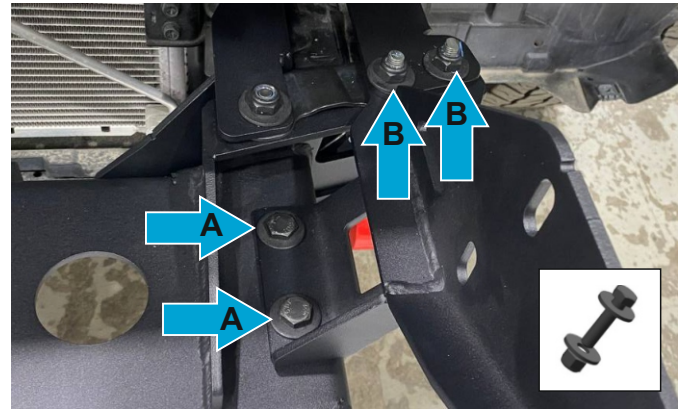

Fig.52

47. Install the bumper body on the winch bracket and fix it on both sides as shown in Fig. 51-52 on both sides:

A - bolts M10x30, penny washers M10, nut M10 (items C4, E3, I3).

B - bolts M10x34, penny washers M10, nut M10 (items C5, E3, I3).

Do not tighten yet.



Fig.53



Fig.54

48. Align the bumper body so that the distance on both sides is the same (Fig. 53-54).

INSTALLATION PROCEDURE

RIVAL

4x4 ACCESSORIES

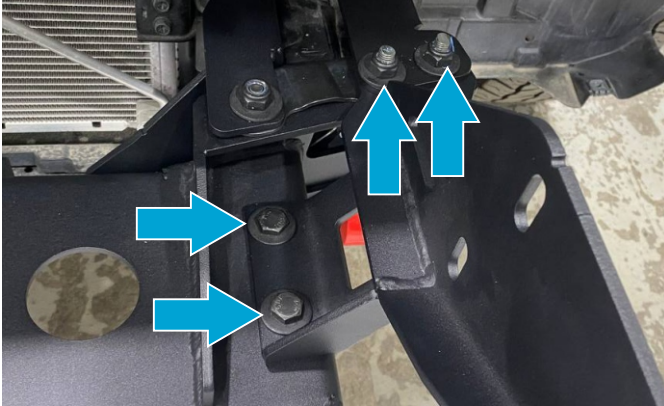

Fig.55

49. Tighten all hardware as shown in Fig. 55
Remove the bumper body.
***Set aside hardware for re-use later on.**



Fig.56

50. Tighten all hardware as shown in Fig. 56.
***On both sides.**



Fig.57

51. Tighten all hardware as shown in Fig. 57.
***On both sides.**

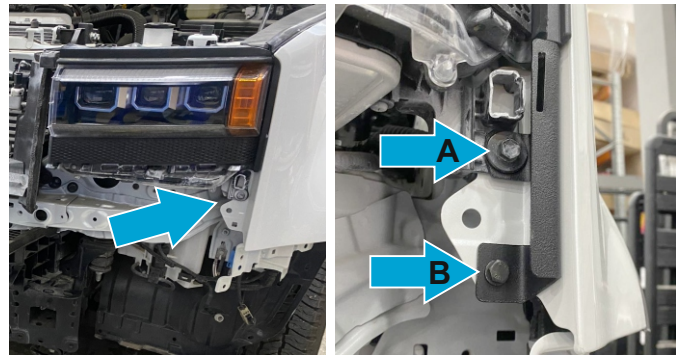

Fig.58

52. Unscrew the OE bolts (A). Install the upper brackets (items 18, 19) on both sides as shown in Fig. 58.
A - OE bolts
B - M6x20 bolts, M6 washers, M6 nuts (items C1, U1, H1).
***Tighten the hardware.**



Fig.59

53. Install the lower brackets (items 16, 17) using M6x20 bolts, M6 washers (items C1, H1) on both sides.
***Tighten the hardware.**



Fig.60

54. Install the central brackets (Fig. 60) using M6x20 bolts, M6 washers (items C1, H1) on both sides.
***Tighten the hardware.**

Winch installation procedure (steps 55-58)

* If you are planning to install winch later, save winch control box and fairlead brackets (items 24, 45, 32, 33).

* If your winch has a control box mounted on top, remove it before installation.



Fig.61

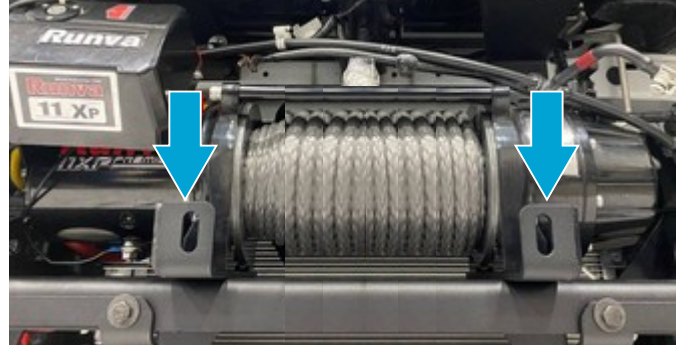

Fig.62

55. Put the winch on pre-installed winch bracket. Insert fairlead brackets (items 32, 33) between the winch and the winch bracket. Next, adjust the fairlead brackets and the winch so that the holes are matched. After that, secure the winch using bolts and nuts that are included with the winch.

***Do not tighten yet.**

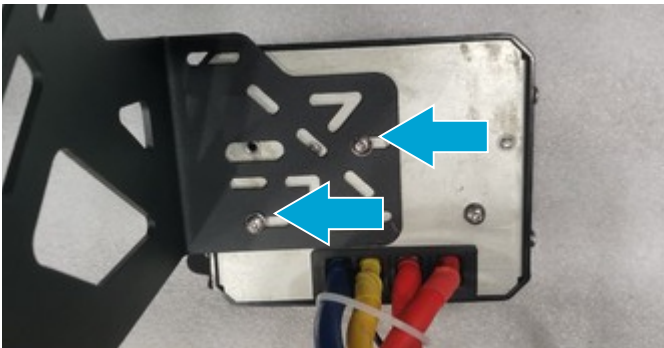

Fig.63

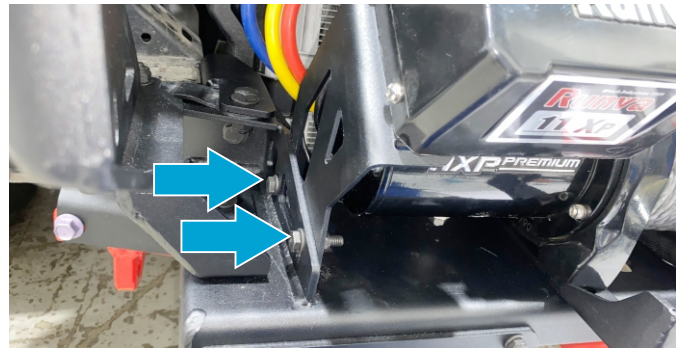

Fig.64

56. Install winch control box to bracket (item 41) using bolts that are included with the winch.

***Tighten the hardware.**

57. Secure winch control box bracket to winch bracket using bolt M8x30, washer M8, nut M8 (items C3, E2, I2).

***Do not tighten yet.**

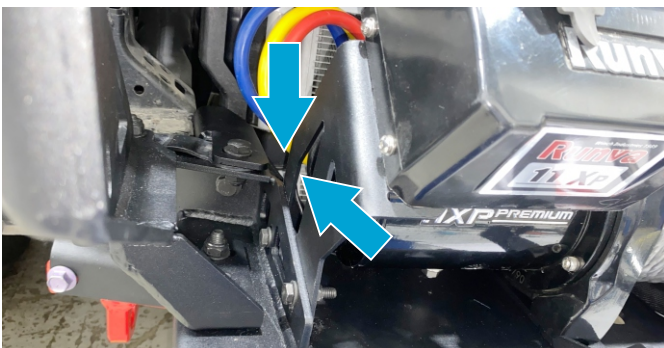

Fig.65

58. By moving and rotating the winch control box on the bracket, find the right position. Position it as close to the winch as possible.

***Tighten the hardware.**

INSTALLATION PROCEDURE

RIVAL

4x4 ACCESSORIES

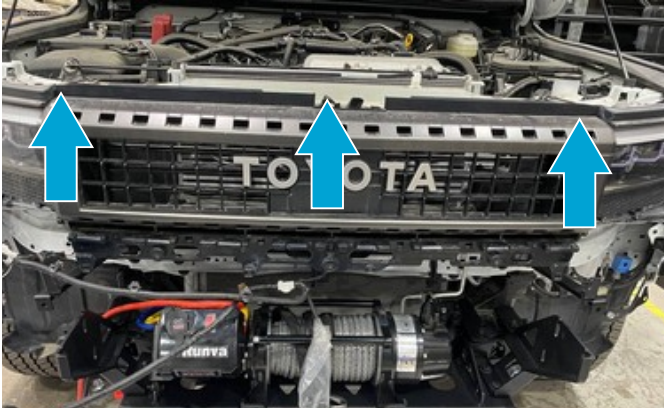

Fig.66

59. Install the radiator grille using OE bolts.



Fig.67

60. Install the right grille bracket (item 10) using M6x20 bolts, M6 washers (items C1, H1).
***Tighten the hardware.**



Fig.68

61. Fix the radiator grille to the right bracket using an M6x20 bolt and an M6 nut (items C1, E1).
***Tighten the hardware.**



Fig.69

62. Install the left grille bracket (item 11) using M6x20 bolts, M6 washers (items C1, H1).
***Tighten the hardware.**

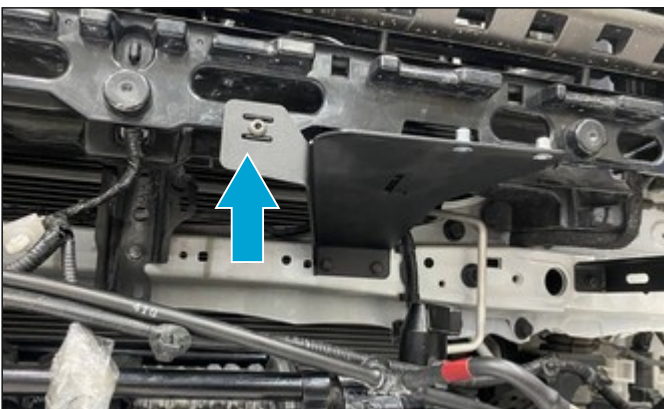

Fig.70

63. Fix the radiator grille to the left bracket using an M6x20 bolt and an M6 nut (items C1, E1).
***Tighten the hardware.**

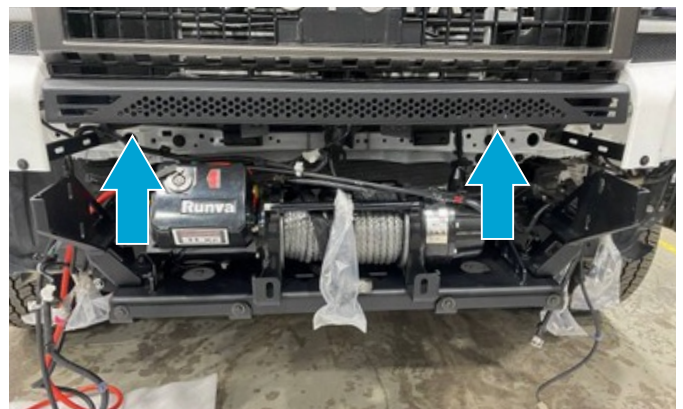

Fig.71

64. Install the grille (item 8) on the grille brackets and on the grooves of the radiator grille OE, using bolts M6x20, penny washers M6 (items C1, I1).
***Tighten the hardware.**



Fig.72

65. Place the OE cover under the headlight on the bracket
***On both sides..**



Fig.73

66. On the inner part of the OE cover, mark the locations of the holes in the brackets, then remove the cover.
***On both sides.**

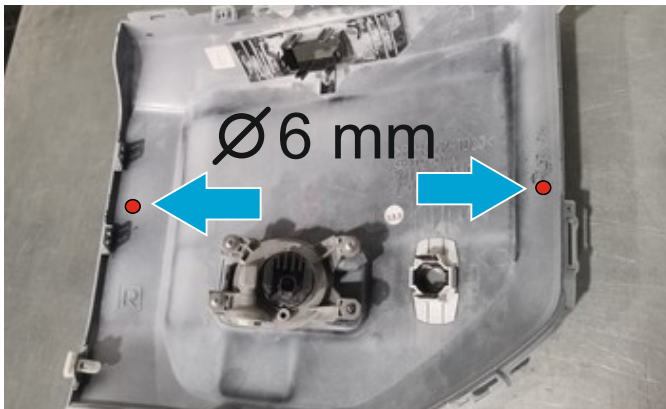

Fig.74

67. Drill 6mm holes at the marked points.



Fig.75

68. Step back 15mm from the holes down. Make marks.



Fig.76

69. Connect the marks and stick on masking tape.



Fig.77

70. Cut the cover along the marked line.

INSTALLATION PROCEDURE



4x4 ACCESSORIES



Fig.78

71. Attach the covers on both sides to the brackets using M6x20 bolts, M6 penny washers, M6 nuts (items C1, I1, E1) on both sides.

***Tighten the hardware.**



Fig.79

72. Install OE fenders and mud flaps using OE hardware.

***On both sides.**

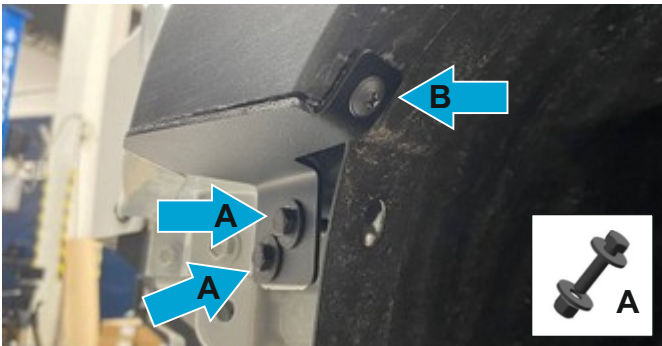

Fig.80

73. Install fender brackets (items 12, 13) using:
A - M6x20 bolts, M6 penny washers, M6 nuts (items C1, E1, I1)

B - screws M4.8x22 (item A)

***Tighten the hardware.**



Fig.81

74. Place the wires in accordance with further connection. Attach using cable ties (item S, qty. 8) so that the wires do not touch the winch.



Fig.82

75. Fix the side plugs (items 1, 3) to the bumper body (item 2) using M8x30 bolts, M8 washers, M8 nuts (items C3, E2, I2).

***Tighten the hardware.**



Fig.83

INSTALLATION PROCEDURE

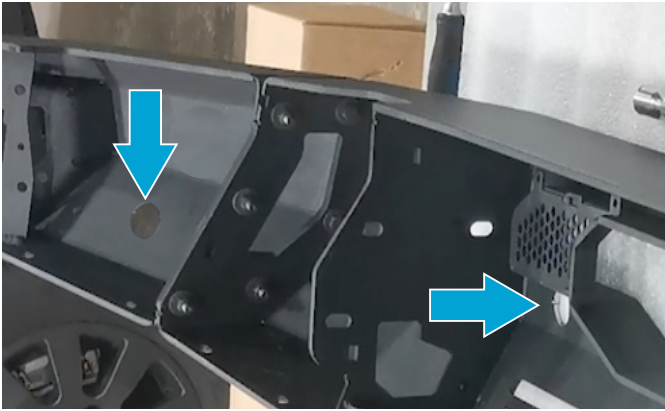

Fig.84

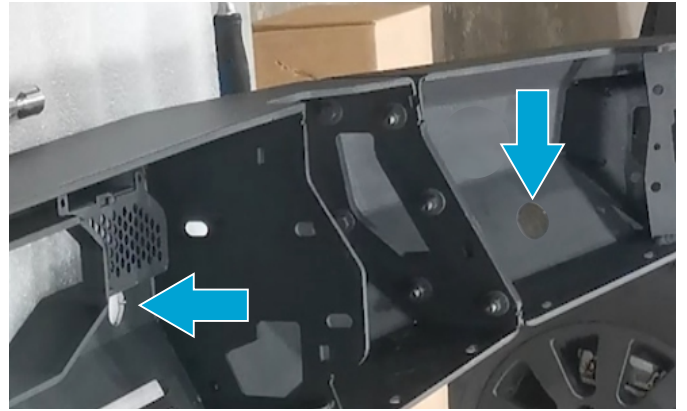

Fig.85

76. If your vehicle is equipped with parking sensors, hammer out the plugs in the bumper body.



Fig.86

77. If your vehicle is equipped with a front camera, hammer out the plug.



Fig.87

78. Hammer out holes for the lightbar installation.



Fig.88

79. Install M6 cage nuts (item G) on the side ends.



Fig.89

80. Install the side radars in accordance with the bumper side using radar brackets, M6x20 screws, M6 washers (items 20, B, I1).
***Tighten the hardware.**



Fig.90



Fig.91

81. Install plastic plugs (items 6, 7) using M6x35 bolts (item C2).
***Tighten the hardware.**

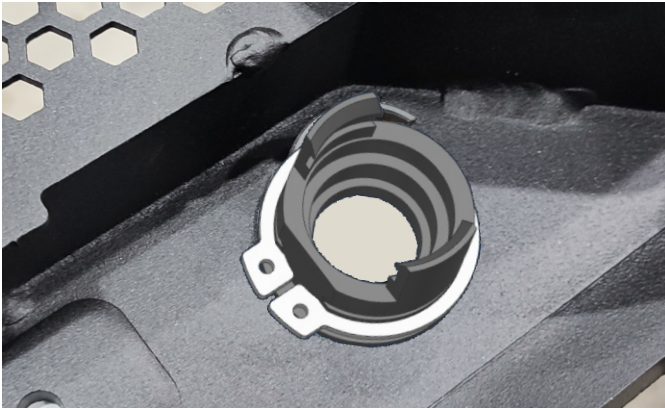

Fig.92

82. Install the parking sensor holders (item R),
fix it using the retaining rings (item Q).

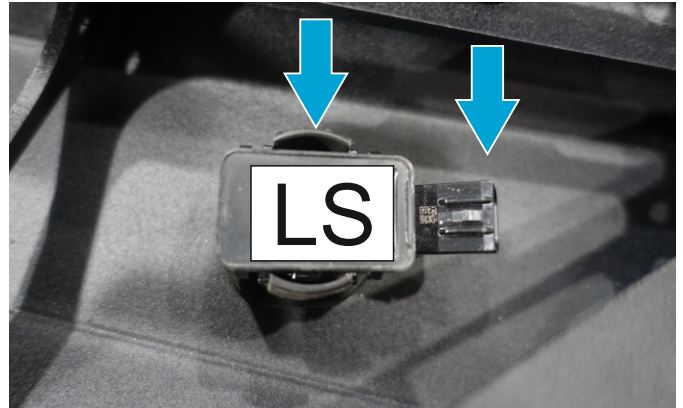

Fig.93

83. Install the parking sensors so that the
connector position is the same as on the OE
bumper.

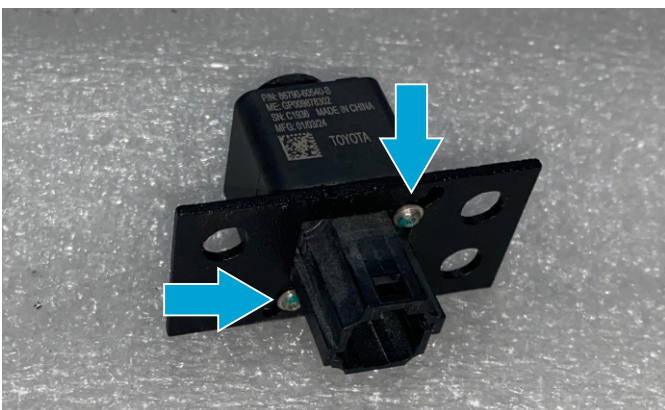

Fig.94

84. Install the camera to the bracket using
OE bolts.

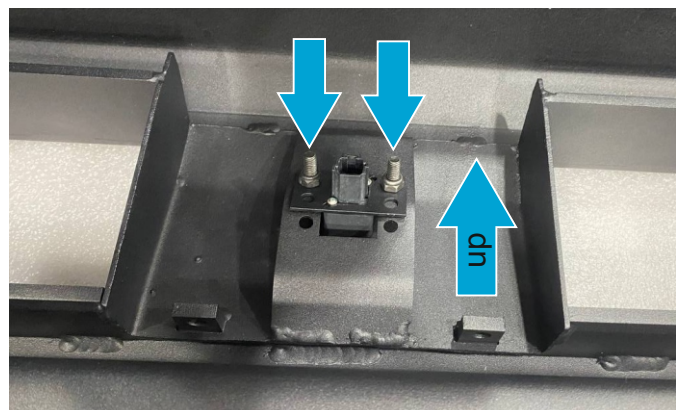

Fig.95

85. Install the bracket with the camera on the
bumper body using M6x20 bolts, M6 nuts
(items C1, E1).
***Tighten the hardware.**

INSTALLATION PROCEDURE



Fig.96

86. Place the bumper on the brackets.

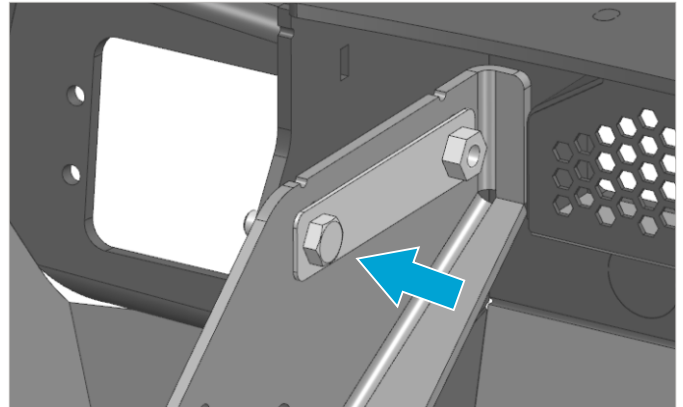

Fig.97

87. Install insert nuts M10 (item O) through central holes of the bumper.
***On both sides.**



Fig.98

88. Secure bumper using screws M10x30, countersunk washers M10, insert nuts M10 (items D, J, O) on both sides.
***Do not tighten yet.**

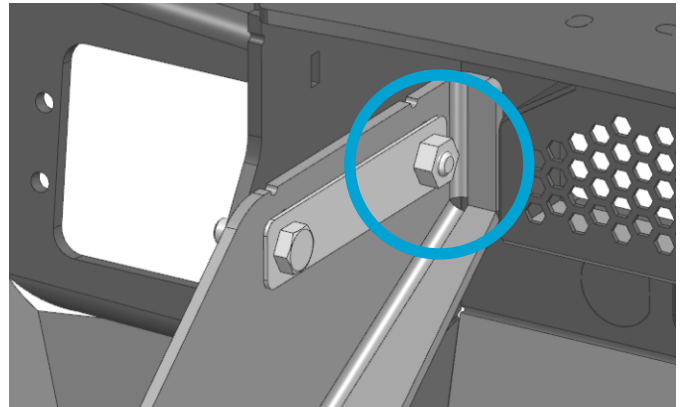

Fig.99

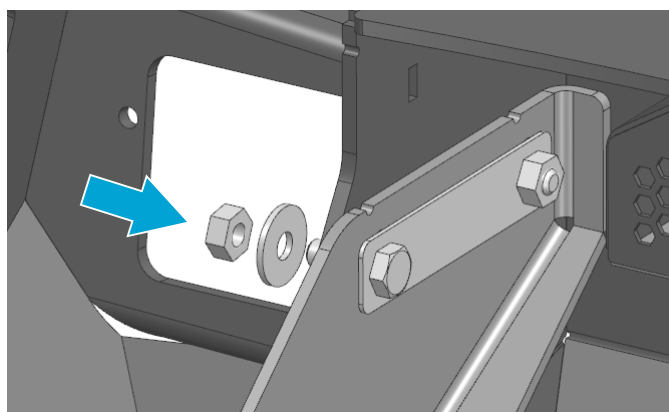

Fig.100

89. Fix bumper using washers M10, nuts M10, insert nuts M10 (items E3, I3, O) on both sides.
***Do not tighten yet.**

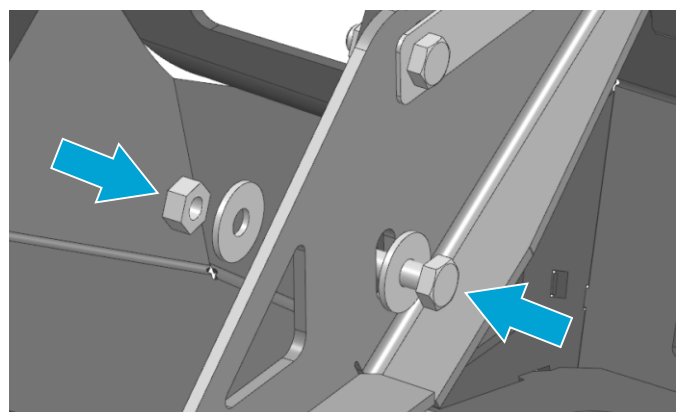

Fig.101

90. Secure the bumper using M10x30 bolts, M10 penny washers, M10 nuts (items C4, E3, I3) on both sides.
***Do not tighten yet.**

INSTALLATION PROCEDURE

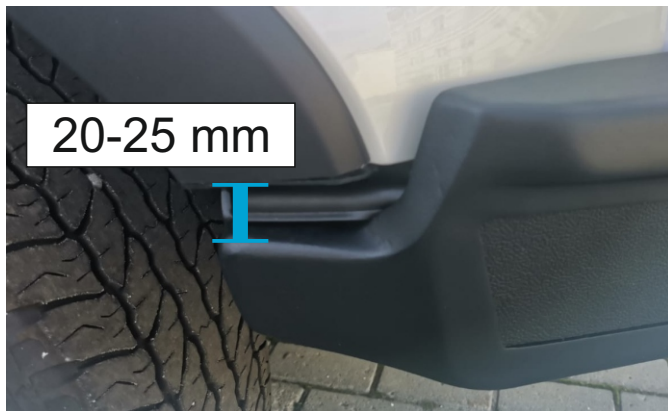

Fig.102

91. Align the bumper so that the distance to the fenders is at least 20-25 mm on both sides.
***Tighten the bumper hardware.**



Fig.103

92. Connect the plugs to the side radars.



Fig.104

93. Connect the plugs to the parking sensors.

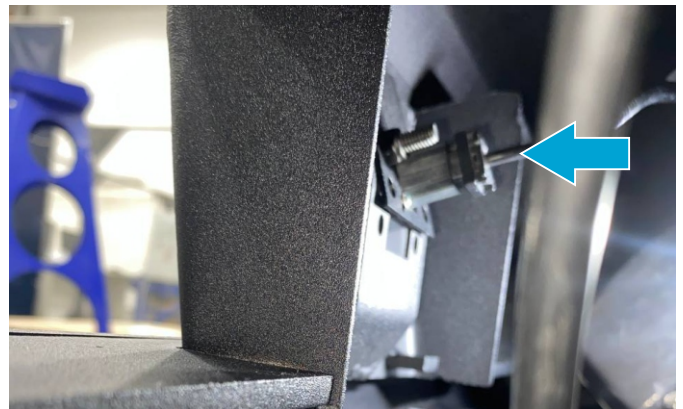

Fig.105

94. Connect the plug to the camera.



Fig.106

95. Connect the hoses to the headlight washer.

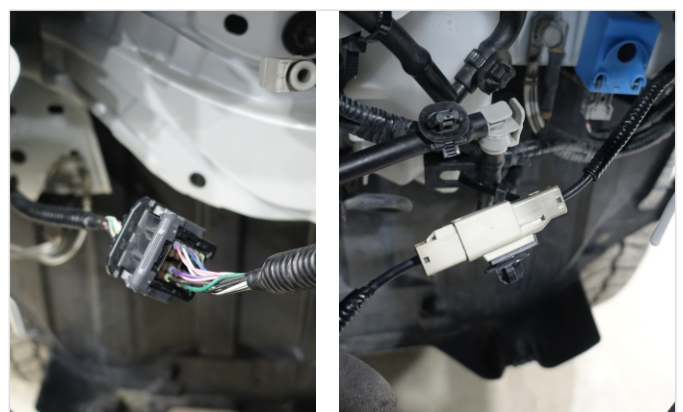

Fig.107

96. Connect the plugs.

INSTALLATION PROCEDURE



4x4 ACCESSORIES



Fig.108

97. **Rival LED lights:** install them using supplied hardware. Use the adapter included from a set of LED.

Others or light caps (item 40): install them using screws M6x20, washers M6 and LED light brackets (items B, H1, 39).

***Tighten the hardware.**

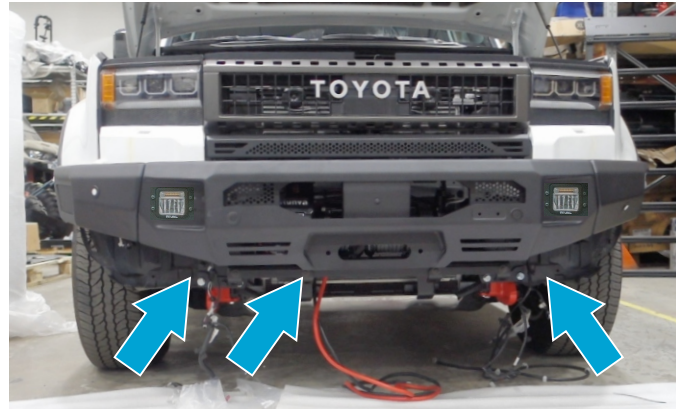

Fig.109

98. Fix the wiring using cable ties on the frame and bumper (item S).

Step 100-103 in case you have lightbar



Fig.110

99. Install lightbar brackets (items 14, 15) to lightbar using lightbar hardware.

***Do not tighten yet.**



Fig.111

100. Install lightbar on the bumper body and secure the brackets using bolts M8x30, washers M8, nuts M8 (items C3, E2, I2). Adjust the lightbar.

***Tighten the hardware.**



Fig.112

101. Install cage nuts M8 (item F) on lightbar cap (item 9) as shown on fig.112.



Fig.113

102. Secure lightbar cap to the bumper body using bolts M8x30, washers M8 (items C3, I2). Adjust lightbar cap.

***Tighten the hardware.**

INSTALLATION PROCEDURE

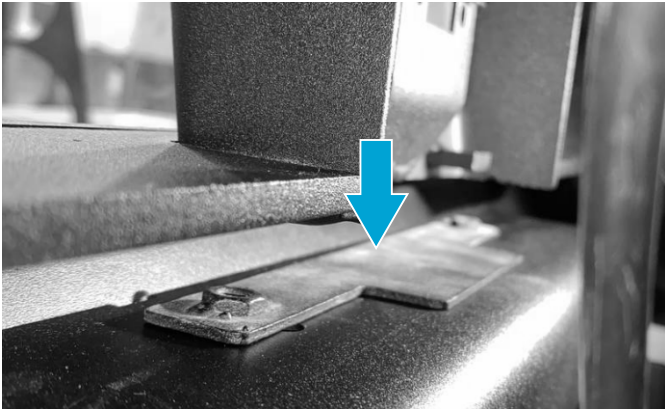

Fig.114

103. Instal license plate insert nut (item 38).



Fig.115

104. Install and secure license plate bracket (item 34) to bumper body using screws M6x20, washers M6 (items C1, H1).
***Do not tighten yet.**

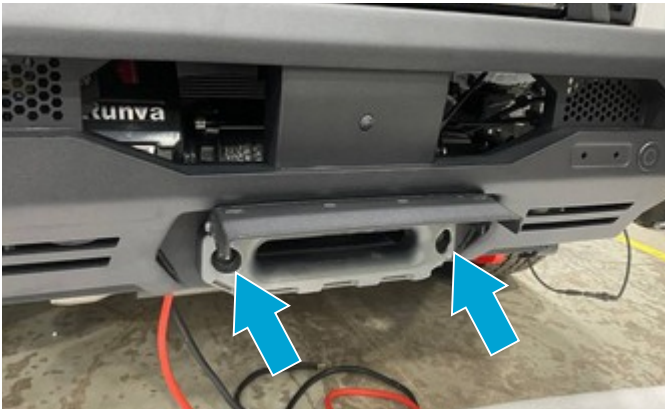

Fig.116

105. Install a fairlead to the bumper using fairlead hardware and insert nuts M10 (item N).
***Tighten hardware from step 55, 106, 107.**

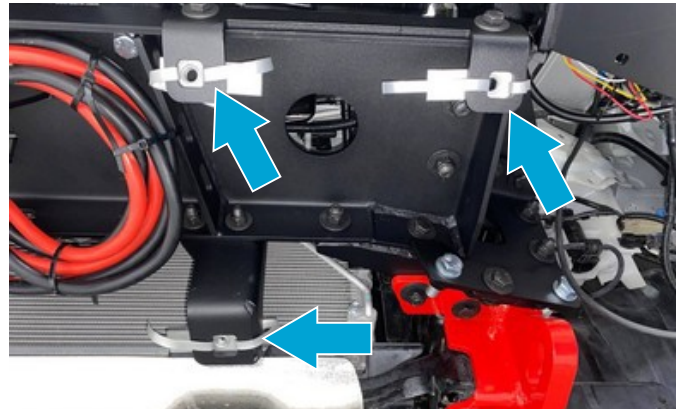

Fig.117

106. Install insert nuts M10 with wires (item L).
***On both sides.**

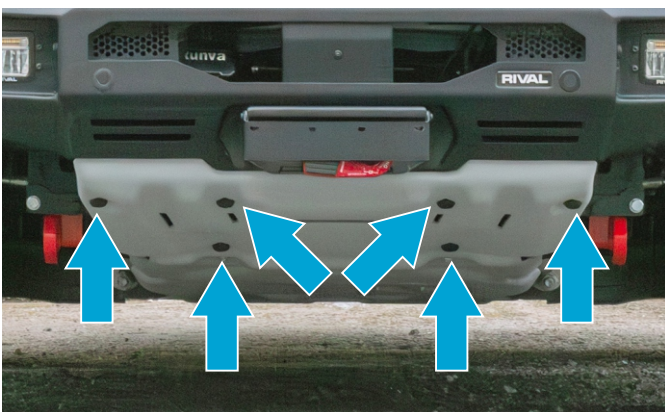

Fig.118

107. Install bash plate (item 44) and secure it using screws M10x30, washers M10 (items D, J). Align the bash plate.
***Tighten the hardware.**



Fig.119

108. Install cage nuts M6 (item G) on flaps (items 4, 5) (fig.120).

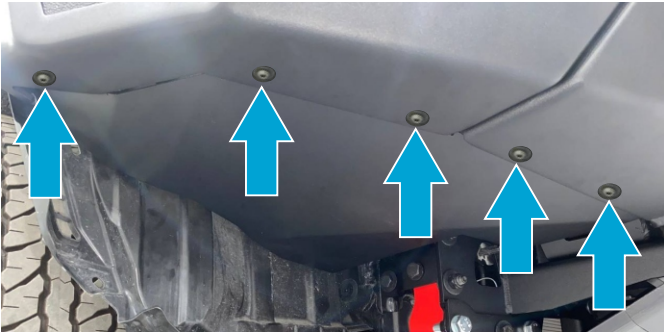

Fig.120

109. Install flaps and secure them using screws M6x20, washers M6 (items B, I1) (fig.120) on both sides of the vehicle
***Do not tighten yet.**



Fig.121

110. Mark a cutting line. Cut plastic inner fender using jig-saw or shears (fig.121). For convenience, the fender can be removed during trimming on both sides of the vehicle

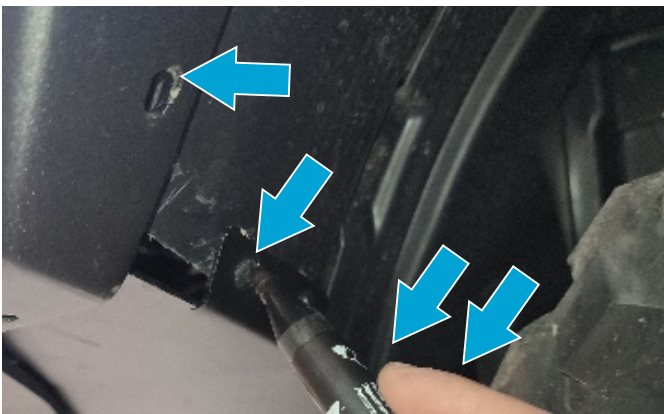

Fig.122

111. Match holes in plastic inner fender with holes in flap. Next, mark the matched holes and extra parts of inner fender on each side of the vehicle (fig.122). For convenience, it is recommended to remove the wheel or turn the wheel to its maximum extent.



Fig.123

112. Drill holes in plastic fender (fig.123).
***On both sides.**

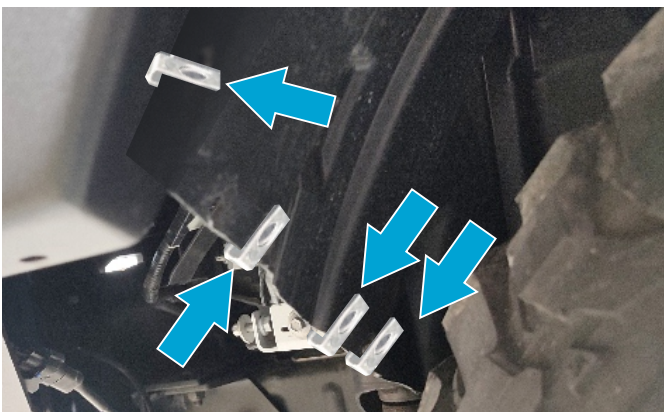

Fig.124

113. Pre-install cage nuts (item G) on plastic fenders.
***On both sides.**

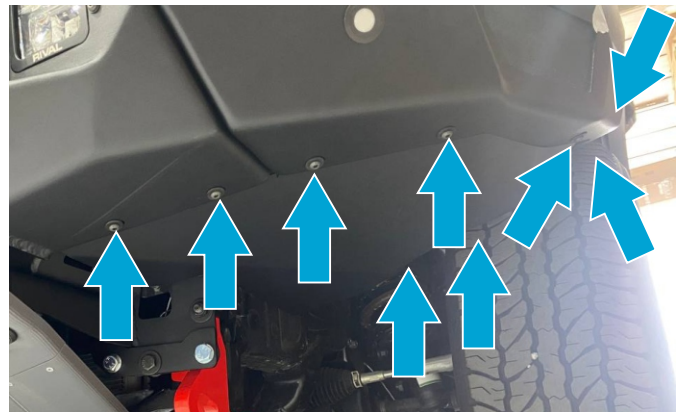

Fig.125

114. Slide and secure flap using screws M6x20, washers M6 (items B, I1) on both sides of the vehicle (fig. 125).
***Tighten the hardware.**

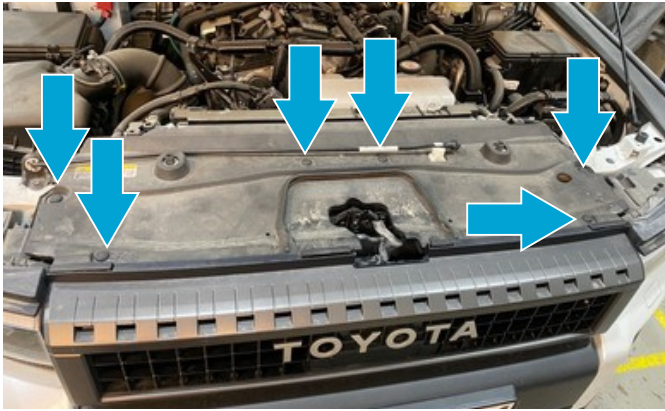

Fig.126

115. Install factory plastic pad clip and secure it using factory clips (fig.126).

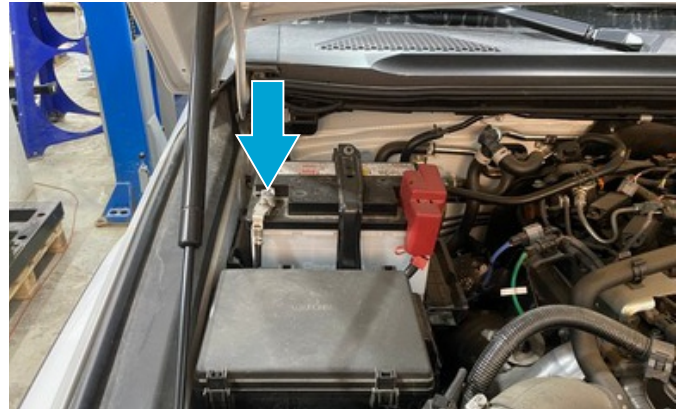

Fig.127

116. Connect terminal "-" on the vehicle battery (fig. 127).

Before operating a vehicle fitted with RIVAL front bumper:

- make sure all fittings are tightened;
- ensure the integrity of the structure and its components.

